

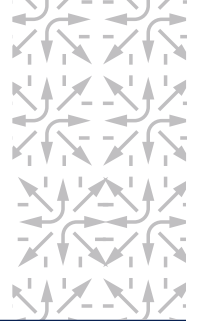

Working mission-critical shifts?
You have our everlasting support.

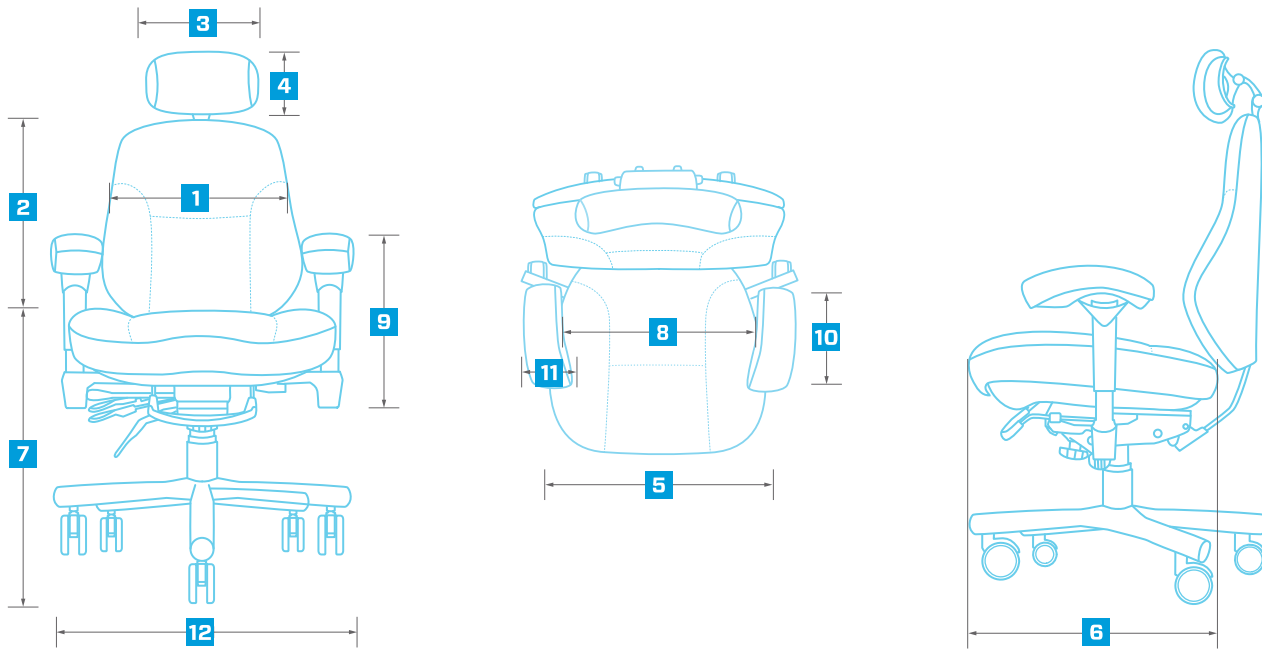

NEXT24 SIZE B



	SPEC DESCRIPTION	MEASUREMENT
1	Backrest Width (shoulder region)	19.00"
	Backrest Width (lumbar region)	23.00"
2	Backrest Height	22.00"
	Backrest Angle Adjustment	15°
	Backrest Height Adjustment	4.00"
	Backrest Depth Adjustment	3.50"
3	Neckroll Width	12.50"
4	Neckroll Height	8.50"
	Neckroll Height Adjustment	3.00"
	Neckroll Depth Adjustment	3.50"
5	Seat Width	23.00"
6	Seat Depth	23.00"
	Seat Depth Adjustment	2.50"

	SPEC DESCRIPTION	MEASUREMENT
7	Seat Height (range)	19.25" - 22.50"
	Seat Height Adjustment	3.25"
	Seat Tilt Adjustment	16°
	Chair Swivel	360°
8	Width Between Armrests (range)	20.50" - 24.50"
9	Armrest Height Adjustment	4.50"
	Armrest Rotation	360°
10	Arm Pad Length	11.00"
11	Arm Pad Width	4.00"
12	Base Diameter	27.00"
	Weight Capacity	300 lbs.

*Specifications are for **13509** (with headrest) & **12509** (without headrest) in standard configuration.

NEXT24



DESIGN YOUR CHAIR

		CODE
NEXT24 - SIZE B		SKY-I
STEP 1	SELECT THE BACK	
	High Back without Neckroll	2509
	High Back with Neckroll	3509
STEP 2	SELECT THE CYLINDER	
	Heavy Duty Short	:YHDS
	Heavy Duty (<i>comes standard</i>)	:YHD
	Heavy Duty Tall	:YHDT
STEP 3	SELECT THE BASE	
	6-Star Metal Base - 27" Diameter (<i>comes standard</i>)	:B14
	5-Star Metal Base - 27" Diameter	:B15
STEP 4	SELECT THE CASTERS	
	3" Soft Surface Casters (<i>comes standard</i>)	:C13
	3" Hard Surface Casters	:C23
	2" Chrome Casters	:C7
STEP 5	SELECT THE FABRIC (<i>SEE FABRIC CARDS FOR FABRIC COLOR OPTIONS</i>)	
	Brisa Original	:BRISA - COLOR
	Staccato	:STACCATO - COLOR
STEP 6	SELECT THE FABRIC STITCHING (<i>ON BRISA FABRIC ONLY</i>)	
	None (<i>comes standard</i>)	-
	Double Stitching - Smooth	:S1
	Double Stitching - Gathered	:S2
STEP 7	CUSTOM OPTIONS	
	No Other Options	-
	Customization (<i>any approved modification not listed in options</i>)	:CU

COMFORT BY DESIGN

IT WORKS. SO YOU CAN WORK.



NEXT-LEVEL INNOVATION FOR INTENSIVE-USE SEATING

Next24 is the only chair embedded with SKYDEX, a patented polymer technology that reduces seated pressure for a more satisfying sitting experience. Combined with the ergonomic design and reliable support of the BodyBilt seat pan, it provides long-shift comfort that conventional foam solutions simply can't touch.

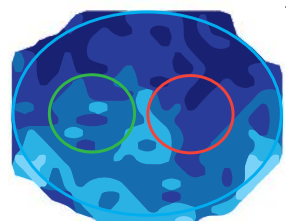

24|Seven Seat Pressure Map

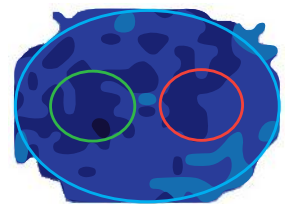

Next24 Seat Pressure Map

COMFORT ON A CURVE

The SKYDEX technology inside every Next24 uses expertly engineered geometries to better distribute seated pressure. For the user, this means **43%** more comfort, **56%** improved impact mitigation and **10x** the durability of standard foam.

The pressure map images to the left show the additional comfort of Next24 compared to BodyBilt's 24|Seven seat. Regions of darkest blue reflect the areas of lowest seated pressure, bringing more comfort to the user.



Next24 pairs SKYDEX technology with the BodyBilt seat pan, ergonomically engineered for seated comfort. Three different sizes, along with two contour options for Size A, allow the seated shift worker to further customize Next24's comfort. These seat options allow Next24 to perfectly position a greater percentage of your workforce.



NEAT NECK SUPPORT

The optional neckroll on Next24 is designed to support the curve of your neck and take the weight of your head off your neck and shoulders.

4-ARM STABILITY

BodyBilt's height-adjustable 4-Arms provide both ergonomic adjustment and stability.

STURDY STEEL CONSTRUCTION

From the heavy-duty cylinder to the reinforced steel brace bars and additional steel plate, Next24 is designed for long-term life and durability. Three different cylinder height options (short, standard, and tall) allow you to choose the correct height for your comfort.

CHOICE OF OPTIONS

Next24 offers the option of three different casters (3" hard surface, 3" soft surface, and 2" chrome) as well as either a six-star or five-star base.



TIME-SAVING STYLE

The non-upholstered back of Next24 provides easier maintenance so you can stay focused on your most critical tasks.



LEVELS OF LUMBAR

Built-in Air Lumbar allows you to adjust the level of lumbar support to perfectly meet your needs.



GREATER ADJUSTABLE RANGE

Next24's adjustments include back height and angle, seat height and tilt tension, and arm width and height adjustment for perfect positioning.

STACCATO (NYLON FABRIC)



AZURE

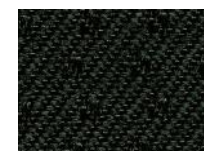

BLACK



NAVY

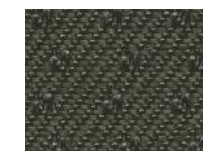

CALCINE GRAY



BURGUNDY

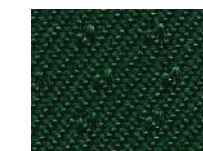

DOUGLAS FIR

BRISA ORIGINAL (LEATHER ALTERNATIVE)



CAMBRIDGE BLUE

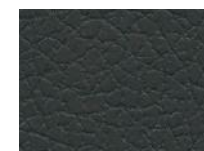

BLACK ONYX



INDIGO



TRUFFLE

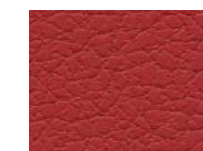

POMPEIAN RED



NEW SAND

Other color options may be available. Contact your local sales representative for more information. Double stitching option is only available with Brisa Original.

WANT 24/7 COMFORT? SIT RIGHT DOWN.



A perfect fit with an extensive range of adjustment, **the NEW Next24 delivers comfort, postural support, and durability.**

SEAT SIZE OPTIONS



B

*Ideal for users 6' tall and taller.
Available with neckroll.*



A

Available without neckroll.



C

*Ideal for users over 300 lbs.
Available without neckroll.*

UNSURPASSED SUSTAINABILITY

In addition to the added comfort, the *SKYDEX* technology offers increased durability. Combining this with BodyBilt's ergonomic and sturdy steel construction, Next24 is ideal for long-shift seating, being both reliable and restful.

ErgoGenesis Workplace Solutions, LLC

Manufacturer of BodyBilt Seating & Ergonomic Workplace Solutions

www.BodyBilt.com | 1.800.364.5299

For more information on Next24, including the Next24 specification sheet with measurement data and additional option details, contact your local sales representative.

